

# Loopwheels for Wheelchairs: Loopwheels Urban, LT and Extreme

## **User Manual**

**EN**

**Thank you for choosing Loopwheels™. We wish you much enjoyment on your wheels.**

BEFORE using this product, read this manual and save for future reference. It contains important information for your safety and for the maintenance of your wheels. In particular, don't exceed 25 km/h.

Find updated user manuals at <https://loopwheels.com/technical/user-manual/>

### **Dealers and Distributors:**

*This manual MUST be given to the user of the product.*

*Do NOT attempt to change bearings without specific advice from [info@loopwheels.com](mailto:info@loopwheels.com), as our bearings are fixed into the wheels.*

# LOOPWHEELS URBAN AND EXTREME

This user manual is available on our website in these languages:



<https://loopwheels.com/technical/user-manual/>

<b>DE</b>		Vielen Dank, dass Sie sich für Loopwheels™ entschieden haben. Wir wünschen Ihnen viel Freude mit Ihren Rädern. Lesen Sie sich das Benutzerhandbuch durch, BEVOR Sie dieses Produkt verwenden.
<b>EN</b>		Thank you for choosing Loopwheels™. We wish you much enjoyment on your wheels. BEFORE using this product, read this manual.
<b>ES</b>		Gracias por elegir Loopwheels™. Esperamos que disfrutes mucho con tus ruedas. ANTES de usar el producto, lee este manual.
<b>FI</b>		Kiitos, että valitsit Loopwheelsit™. Toivotamme sinulle hyviä hetkiä pyörien päällä. Lue tämä opas ENNEN tuotteen käyttöä
<b>FR</b>		Merci d'avoir choisi Loopwheels™. Nous espérons que ces roues vous donneront pleinement satisfaction. AVANT d'utiliser ce produit, lisez le manuel
<b>IT</b>		Grazie per aver scelto Loopwheels™. Vi auguriamo il massimo divertimento con queste ruote. PRIMA di utilizzare questo prodotto, leggere il manuale

<b>JP</b>		<p>Loopwheels™をお選びいただきありがとうございます。このホイールで快適に過ごされることを願っております。ご使用になる前に、本フイツフガイドと共に、ご購入Loopwheels製品の正式なユーザーマニュアルをお読みください。両文書は、当社ウェブサイト (<a href="https://loopwheels.com/technical/user-manual/">https://loopwheels.com/technical/user-manual/</a>) にてご入手いただけます。</p>
<b>KOR</b>		<p>Loopwheels™를 선택해 주셔서 감사합니다. 만족스러운 제품 사용 경험을 얻게 되시기 바랍니다. 제품을 사용하기 전에 본 퀵 가이드를 읽으시고, 사용자 설명서에서 Loopwheels에 대한 자세한 내용을 참조하세요. 두 문서는 모두 당사의 웹사이트 (<a href="https://loopwheels.com/technical/user-manual/">https://loopwheels.com/technical/user-manual/</a>)에서 찾으실 수 있습니다.</p>
<b>NL</b>		<p>Hartelijk dank dat je hebt gekozen voor Loopwheels™. We wensen je veel plezier op je wielen. VOORDAT je dit product gaat gebruiken: lees de handleiding.</p>



# Contents:

1. GENERAL INFORMATION AND WARRANTY
  - 1.1 Information about the User Manual
  - 1.2 Symbols in this manual
  - 1.3 Warranty
  - 1.4 Intended use
  - 1.5 Limitation of liability
2. PRODUCT IDENTIFICATION
3. SAFETY
  - 3.1 General Safety Information and Operating Limits
4. COMPONENTS AND THEIR FUNCTIONS
  - 4.1 Overview of components
  - 4.2 Bearings
  - 4.3 Springs
5. ACCESSORIES
  - 5.1 Tyres
  - 5.2 Spacers
  - 5.3. Removable Axles
    - 5.3.1 Axle diameter
    - 5.3.2 Axle length
    - 5.3.3 Loopwheels quick-release axles
6. FITTING LOOPWHEELS™ TO YOUR WHEELCHAIR
  - 6.1. Fitting Loopwheels™ to your wheelchair for the first time
  - 6.2 Fitting and removing loopwheels™ in everyday use
    - 6.2.1 Fitting Loopwheels™ on subsequent occasions
    - 6.2.2 Removing Loopwheels™
7. USING LOOPWHEELS™
  - 7.1 Braking
  - 7.2 Driving and steering a wheelchair fitted with loopwheels™
8. MAINTENANCE
  - 8.1 Safety Information
  - 8.2 Maintenance Schedule
  - 8.3 Repairing or changing an inner tube
  - 8.4 Cleaning
9. TROUBLESHOOTING
  - 9.1 Safety Information
  - 9.2 Identifying and repairing faults
10. AFTER USE
  - 10.1 Safety
  - 10.2 Disposal
11. TECHNICAL DATA
  - 11.1 Dimensions and weight
  - 11.2 Environmental conditions
  - 11.3 Materials

# 1. General Information and Warranty



## 1.1 Information about the User Manual

This User Manual contains important information about your new wheels, to ensure your safety and prevent damage when fitting your wheels to your chair, and to avoid invalidating your product warranty.

For the latest product information, please refer to our website at [www.loopwheels.com](http://www.loopwheels.com), your local Loopwheels™ dealer, or contact the Loopwheels™ distributor in your country (see [www.loopwheels.com/stockists](http://www.loopwheels.com/stockists)).

## 1.2 Symbols in this manual

In this User Manual warnings are indicated by symbols. The warning symbols are accompanied by a heading that indicates the severity.

 <b>WARNING</b>	Indicates a hazardous situation that could result in serious injury or death if it is not avoided.
 <b>CAUTION</b>	Indicates a hazardous situation that could result in minor or slight injury if it is not avoided.
 <b>IMPORTANT</b>	Indicates a hazardous situation that could result in damage to property if it is not avoided.

## 1.3 Warranty

Jelly Products Ltd guarantees that our products are free from defects and are fully functional. The warranty covers all faults and defects that are verifiably attributable to faulty construction, substandard materials or poor workmanship. Warranty claims should be made through the dealer or distributor from whom the product was bought. Claims should only be made to the manufacturer if the product was purchased directly from us. The warranty does not cover normal wear and tear, the consequences of improper handling or damage, poor maintenance and incorrect assembly or commissioning by the purchaser or a third person, or faults which are attributable to circumstances beyond our control. Wearing parts (i.e. tyres, inner tubes and bearings) are not covered by the guarantee. The warranty is voided if modifications are made to the product or if inappropriate accessories or spare parts are used. The warranty does not cover consequential costs arising from the rectification of defects such as freight and travel expenses, labour costs, fees etc. The term of the manufacturer's warranty is 12 months from the date of purchase. Your statutory rights are not affected.

## **1.4 Intended use**

Loopwheels™ are intended to improve comfort and mobility for people who use a manual wheelchair. Loopwheels™ Urban and Extreme are wheels with integral suspension designed for use as an accessory to a manual wheelchair with the purposes of making it easier for a person in a manual wheelchair to pass over uneven surfaces and reducing the jolting and vibration felt by the person using a manual wheelchair.

Loopwheels™ Urban and Extreme are designed for use with a pneumatic tyre at speeds of up to 25km/h. They may be used with a manual wheelchair to which a power attachment is attached as long as the maximum speed of 25 km/h is not exceeded. Suitable manual wheelchairs include those designed for active and semi- active use, and chairs designed to be pushed by an assistant.

Indications: adolescents and adults who use a wheelchair and weigh between 30kg and 100kg .

Contra-indications: none associated with proper use.

## **1.5 Limitation of liability**

Jelly Products Ltd accepts no liability for damage arising from:

- Non-compliance with the User Manual
- Incorrect use
- Natural wear and tear
- Incorrect assembly or set-up by the purchaser or a third party
- Technical modifications
- The usage of unapproved 3rd party accessories.
- Unauthorised modifications and/or use of unsuitable spare parts
- Removal of bearings
- Removal of logos (as this will damage the UV protective lacquer on the surface of the springs.)

The maximum warrantied speed limit is 25 km/h.

## 2. Product Identification

### 2.1 Unique Product Identification

Each wheel has a serial number on the hub. This enables full traceability of each wheel.

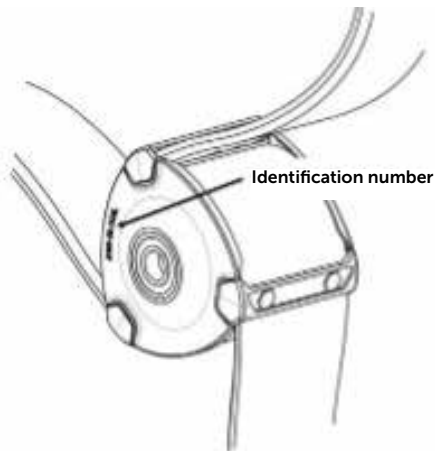

## 3. Safety

### 3.1 General Safety information

General safety advice for using a wheelchair applies. We recognise that people use their chairs in their own ways, and we believe people should always do what they have found to work best for them as individuals.

Nevertheless, this manual contains important safety information for the protection of the wheelchair user and assistant, and for safe, trouble-free use of Loopwheels™ Extreme and Urban.

Each section contains specific safety advice. In particular:

- Don't exceed the recommended load (user, chair and baggage) of 120kg
- Don't exceed the maximum speed of 25 km/h.
- Check the Loopwheels move freely and don't touch any part of the wheelchair when spinning.
- Ensure you have the correct size wheels, wheel bearing, and quick release axle for your wheelchair.

- Ensure you have the correct size wheels, wheel bearing, and quick release axle for your wheelchair.
- Check the axles are fully engaged in the wheelchair housing. See section 6.
- Fitting loopwheels™ to your chair changes the feel of the wheelchair compared with spoked wheels, and may change the centre of gravity. Before driving without assistance, you must accustom yourself to how the chair feels and behaves.
- Adjust your driving style and speed to the conditions and who and what is around you (weather, surface, individual ability and experience, people and obstacles). There is a risk of skidding on wet ground, gravel or uneven terrain.

## **⚠ WARNING**

Risk of serious injury from unexpected wheel braking.

- Loopwheels™ must not be used with a rigid guard over the top of the tyres unless there is a gap of 30mm between the guard and the tyre. There is a risk that whilst moving the wheels could touch the guard and cause sudden braking .
- Check there is a space of 30mm above the tyre at all times.

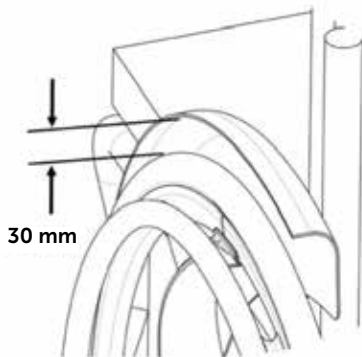

- There's a risk of getting fingers, clothing or other items caught in the moving wheel, between the wheel and the chair, or in removable parts such as the axle. Take care when fitting and using Loopwheels that nothing becomes caught.
- CAUTION! Don't mount with excessively high camber



Camber is the angle or slope at which your wheels are mounted to your chair. Each additional degree of camber adds 1 cm to the width at each side of your chair. The greater camber adds stability, better turning and more space for your hands. To some extent this is personal choice - BUT Loopwheels must not be mounted at a camber angle that exceeds 12 degrees and we recommend a maximum of 3 degrees for most customers.

## 4. Components and their Functions

### 4.1 Overview of components

Loopwheels™ Urban and Loopwheels™ Extreme are wheels with integral suspension for use with manual wheelchairs.

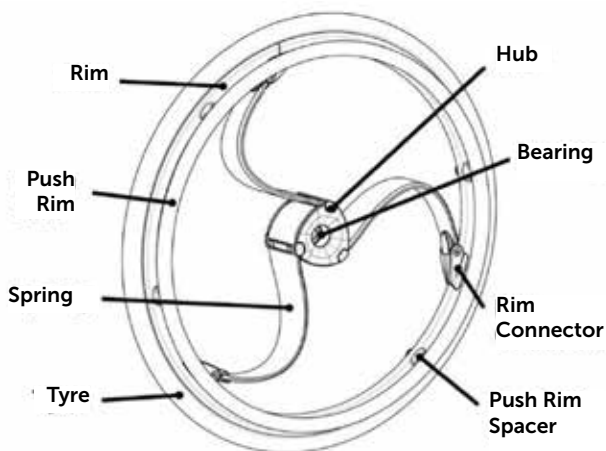

Your wheel may differ slightly from the diagram as each loopwheel is manufactured individually to the specifications in the order.

### 4.2 Bearings

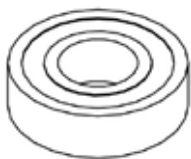

#### **⚠ IMPORTANT**

- You may seriously damage your wheel if you remove the bearings by force.

The bearings are fixed into the wheel hub.

**DO NOT ATTEMPT TO REMOVE OR CHANGE THE BEARINGS YOURSELF!**

Seek advice from us about the correct procedure for removing bearings from Loopwheels™.

If you wish to be able to change your bearings yourself, please specify when you order Loopwheels™ that you wish them to be supplied with unfixed bearings.

### 4.3 Springs

Loopwheels™ Urban and Loopwheels™ Extreme have three springs in each wheel made from carbon composite material.

Loopwheels™ Urban has three spring rates: soft, regular and stiff, and Loopwheels™ Extreme has two spring rates: regular and stiff.

Spring rates are denoted with a spot on the hub:

- Red spot** = Stiff spring rate
- Yellow spot** = Regular spring rate
- Green spot** = Soft spring rate.

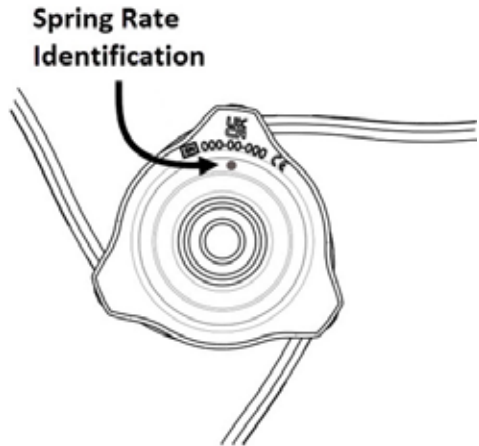

For people at the higher weight end and for use at faster speeds, we recommend a stiffer spring. For people at lower weights we recommend a softer spring.

Which spring rate feels right for you is also a matter of personal preference.



## 5. ACCESSORIES

### 5.1 Tyres

We recommend a pneumatic tyre such as Schwalbe® Marathon Plus tyres for use with Loopwheels™.

#### **IMPORTANT**

You may damage your wheels if you use them with solid tyres.

Do not use solid tyres with Loopwheels.

The size of the tyre is marked on the sidewall of the tyre.

For a Loopwheel Urban 24", you need a tyre size ETRTO 25-540 or 24 x 1.00 inch

For a Loopwheel Urban 25", you need a tyre size ETRTO 25-559 or 25 x 1.00 inch

For a Loopwheel Extreme, you need a tyre size ETRTO 47-507 or 24 x 1.75 inch

The ideal pressure depends on the tyre type, load and your personal preference. The minimum and maximum pressure is marked on the side of the tyre. Keep the pressure inflated between the minimum and maximum levels recommended by the tire manufacturer.

In case of a tyre puncture consult a suitable workshop (e.g. bike repair shop, bicycle or mobility equipment dealer) to have the tube replaced by a skilled person, or replace it yourself following the instructions in section 9.2

#### **CAUTION**

The tyre pressure needs to be maintained at the recommended level in both wheels to avoid decreased driving comfort, to keep the parking brakes on your chair working properly, and to ease propelling of the wheels and your wheelchair. See 9.2 for our recommended maintenance schedule.

## 5.2 Removable Axles

Loopwheels™ must be fitted to a wheelchair using a removable axle designed for use with a manual wheelchair.



### **⚠ WARNING**

**RISK OF OVERTURNING!** There is a risk of overturning your wheelchair due to using an incorrect size axle being used to fit Loopwheels™ to your wheelchair. The axle must be the correct length and diameter so that the loopwheel is firmly attached to your wheelchair for safe use.

- Choose a loopwheel with the same axle diameter as your wheelchair's axle housing.
- Choose the length of axle that attaches the loopwheel to your chair firmly, so that the axle engages correctly in the axle housing of the wheelchair.

### **Axle diameter**

Wheelchair axles are available in two diameters: ½ inch (12.7mm) or 12mm. You must choose the diameter of axle that matches the specification of your wheelchair:

- It is not possible to fit a ½ inch or 12.7mm removable axle shaft into a 12mm axle housing.
- A 12mm axle shaft can be easily inserted into a 12.7mm axle housing but the 0.7mm difference in size will cause your wheels to wobble.

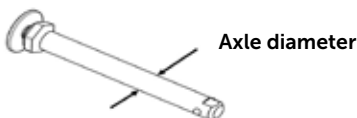

## Axle length

Wheelchair axles are available in several lengths. You must choose the correct length of axle that will pass right through the loopwheel into the wheelchair's axle housing, and engage so it holds the wheel firmly in place (see section 6).

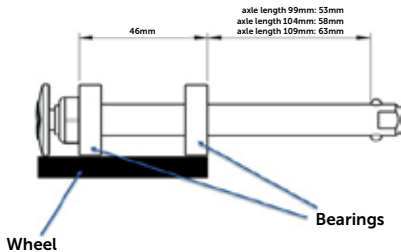

Bearing Position in a Loopwheel

## Loopwheels™ quick-release axles

Our axles are “quick-release”: by pressing the button with the Loopwheels™ logo, the axle disengages.

You can make a minor adjustment to the axle length by rotating the nut, like this:

Step 1: Remove the axle from the wheel.

Step 2: Clamp the flat section to hold it still.

Step 3: Turn the nut using a spanner / wrench. Rotate clockwise to shorten the length of the axle or rotate counter-clockwise to lengthen the axle. The maximum total adjustment is 8mm.

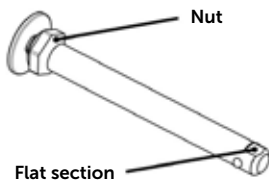

## 5.3 Spacers

We provide 2 stainless steel and 1 rubber spacer with each Loopwheel. This helps to ensure a snug fit of the wheels on your wheelchair and help prevent the wheels touching the chair. Depending on the model and specification of your chair, you may or may not need to use these.

Please refer to section 6 on how to fit Loopwheels™ to your chair for instructions on how to use the spacers.

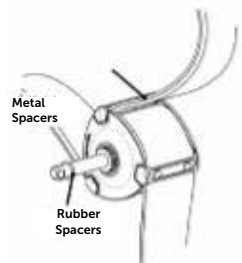

# 6. Fitting Loopwheels to your wheelchair™

## 6.1 Safety information

### WARNING

Risk of serious injury from overturning the wheelchair

- Always ensure that the removable axles are fully engaged whenever you fit a wheel.

### WARNING

Risk of serious injury from overturning the wheelchair

Loopwheels™ must NOT be used with a rigid guard over the top of the tyres unless there is a gap of 30mm between the guard and the tyre. There is a risk that the wheels could touch the guard and cause sudden braking whilst you are moving.

Check there is a space of 30mm above the tyre at all times.

### WARNING

Risk due to using an incorrect size of Loopwheels™ being fitted to your wheelchair. The size of loopwheel must match the specification of your wheelchair for safe performance.

- Choose a wheel of the correct diameter for your wheelchair
- Choose a loopwheel with the same axle diameter as your wheelchair axle housing.

### CAUTION

Risk of injury

- Before using the wheels, check their general condition, refer to 9.2 Maintenance Schedule.

## 6.2 Check you have the correct size Loopwheels™ for your wheelchair

Loopwheels™ Urban is available in 2 sizes: 540mm in diameter, which is a standard 24" wheel when fitted with a standard size tyre, or 559mm in diameter, which is a standard 25" wheel size.

Loopwheels™ Extreme is 507mm in diameter. It is designed to use with a wider Mountain Bike Tyre and still keep the total wheel diameter with tyre to 24"

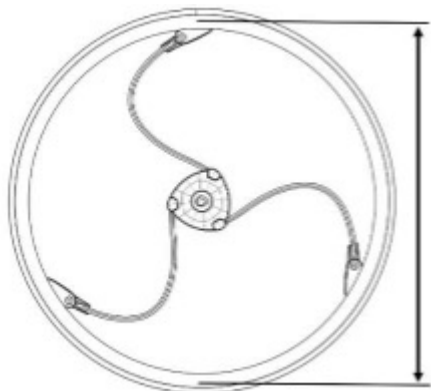

If you don't know the size of wheel that is suitable for you and for your wheelchair, seek advice from your dealer, healthcare provider or therapist.

Loopwheels™ are available with two sizes of axle bearing. We offer an internal diameter of

- ½ inch (or 12.7mm) - the most common size; or
- 12mm

### Internal Bearing Diameter

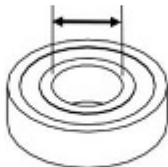

See section 5.2 for advice on axle diameters and lengths. If you don't know the diameter of the axle housing of your wheelchair, seek advice from the dealer from whom you purchased your chair or your Loopwheels™, or from your healthcare provider or therapist

## 6.4 Fitting Loopwheels™ to your wheelchair for the first time

A: IF YOU HAVE PURCHASED LOOPWHEELS™ FROM A SPECIALIST DEALER

Your dealer will supply your Loopwheels™ ready for use. Your dealer will explain the main functions and ensure that the wheels meet your needs and requirements. Your dealer will fit the wheels to your wheelchair.

B: IF YOU HAVE PURCHASED LOOPWHEELS™ WITHOUT HELP FROM A DEALER

If you fit Loopwheels™ to your wheelchair yourself, you must follow these instructions:

Note: you must sit somewhere other than your wheelchair to remove your old wheels and to fit Loopwheels™!

STEP 1. Release the brakes.

STEP 2. With one hand, hold the wheelchair upright.

STEP 3. With the other, remove your old wheels from the wheelchair by pressing the centre of the axle.

STEP 4. Remove the existing axles from your old wheels. You can choose to re-use these or use new axles with your Loopwheels™.

STEP 5. Look for the product identification number on each wheel. This side is the inward facing side of the wheel.

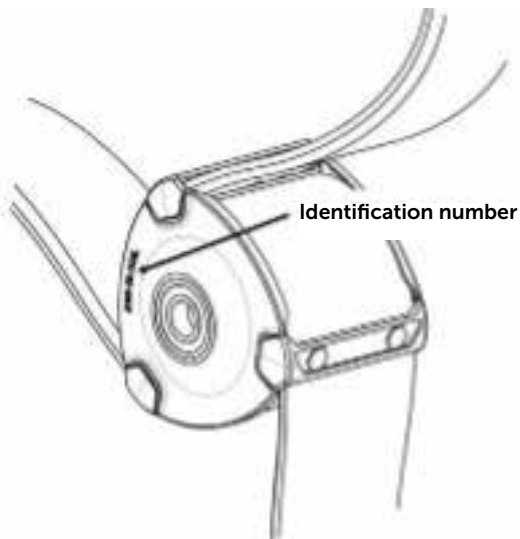



STEP 6: Push one axle into each Loopwheel™ from the other, outward facing side of the wheel.

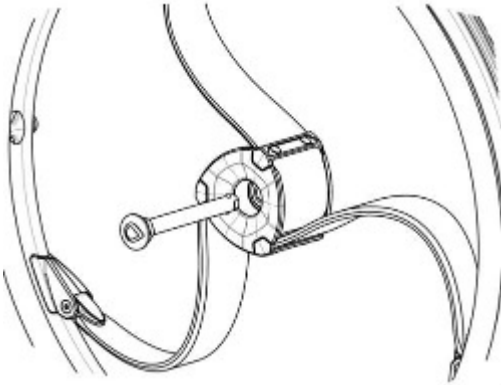

STEP 7. Insert the axle (with the wheel on it) into the axle housing on your wheelchair, one side at a time.

STEP 8: Rotate the wheel slowly to check that no part of the Loopwheel™ touches or rubs the frame of the chair. We recommend a minimum clearance of 10mm at all points.

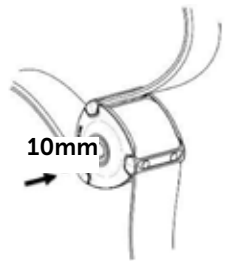

In addition, there must be a space of 30mm above the wheel.

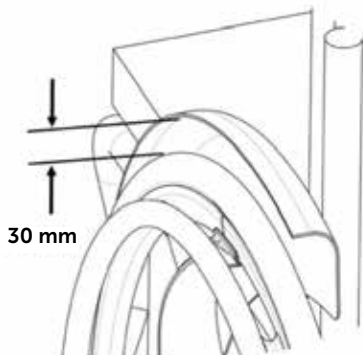

**If the clearance is good, move to STEP 12.**

If there is a clash or not enough clearance, move to STEP 9.

STEP 9: Remove the Loopwheel from the chair, place one of the steel spacers onto the axle from the INNER side of the wheel. This will move the Loopwheel further away from the wheelchair frame. Repeat Steps 8 and 9 up to a maximum of 3 times until there is the correct amount of clearance between the wheel and the frame of the chair.

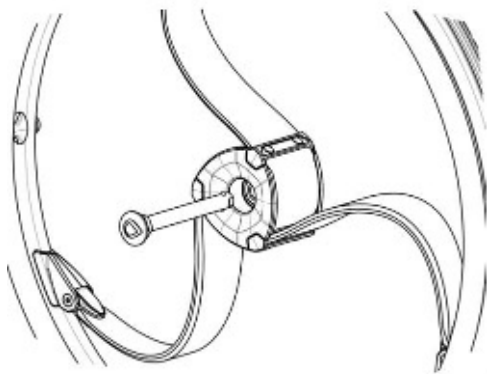

STEP 10: Secure the steel spacers in place by sliding the rubber washer onto the Loopwheel™ axle.

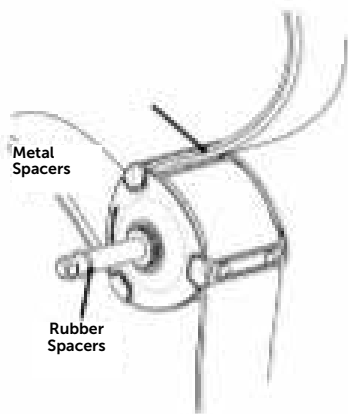

STEP 11: Replace the wheels onto the chair.

**STEP 12: Check that the removable axles are fully engaged in the axle housing of the wheelchair.**

STEP 13: Check that the brakes still engage properly with the tyre. If they do not, seek advice from your wheelchair supplier or therapist on re-positioning the brakes.

## 6.5 Fitting and removing Loopwheels™ in everyday use

### **⚠ WARNING**

Always ensure that the removable axles are fully engaged whenever you fit a wheel.

### **Fitting Loopwheels™**

STEP 1. Release the brakes.

STEP 2. With one hand, hold the wheelchair upright.

STEP 3. With the other, hold the wheel around the wheel hub.

STEP 4. Using your thumb, press the removable axle button and hold it down.

STEP 5. Push the axle into the wheelchair axle housing up to the stop.

STEP 6. Release the removable axle button and make sure that the wheel is secure.

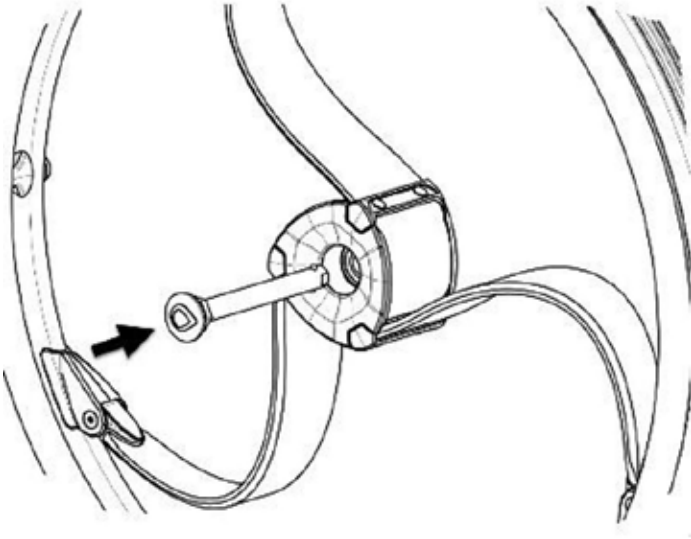

## Removing Loopwheels™

STEP 1. Release the brakes.

STEP 2. With one hand, hold the wheelchair upright.

STEP 3. With the other, hold the wheel around the wheel hub.

STEP 4. Using your thumb, press the removable axle button and hold it down.

STEP 5. Pull the axle out of the wheelchair axle housing

## 7. USING LOOPWHEELS™

### 7.1 Safety information

#### **⚠ WARNING**

Risk of accidents from travelling at speed:

- Do not exceed a safe speed for the environment in which you're travelling.
- Abide by road traffic regulations. Do not exceed 25 km/h in any event.

## **⚠ WARNING**

Risk of accidents: Uneven tyre pressure can have a huge effect on handling. The pressure should be the same in both tyres.

- Check the tyre pressure before each journey

## **⚠ CAUTION**

Risk of crushing:

- There may be a very small gap between the loopwheel and the mudguard with the risk that you could trap your fingers.
- Ensure that you always propel your wheelchair using the handrims only.

## **7.2 Braking during use**

Whilst you are moving, you brake by transferring force to the push rim with your hands.

## **⚠ CAUTION**

Risk of burning your hands:

- If you brake for a long time, a lot of frictional heat is produced at the push rims
- Wear suitable gloves.

1. Hold the handrims and press evenly with both hands until the wheelchair stops.

## **7.3 Driving and steering a wheelchair fitted with Loopwheels™**

You drive and steer a wheelchair using the push rims. Fitting Loopwheels™ to your chair changes the feel of the wheelchair compared with spoked wheels. Before driving without an assistant, accustom yourself to how the chair feels and behaves.

Loopwheels are a suspension system. They are not rigid like spoked wheels and don't run as true as spoked wheels. Slight movement or lack of trueness is not a fault, but is a feature of the product.

**⚠ WARNING**

Risk of falling out of the wheelchair!

- When using Loopwheels™ on a wheelchair that you're used to using with rigid spoked wheels, the centre of gravity may change.
- Find your wheelchair's tipping point and use Loopwheels™ initially with an assistant
- Adjust your driving style accordingly.

**⚠ WARNING**

Use of a wheelchair on rough terrain may be difficult especially if you're used to driving on flat surfaces.

- Adjust driving style and speed accordingly

## 8. MAINTENANCE

### 8.1 Safety Information

#### WARNING

Some materials deteriorate naturally over time. Wheelchair manufacturers recommend that your wheelchair should be checked by a specialist dealer at least once a year or if it has not been used for a long period. We recommend your Loopwheels™ are included in this annual check.

### 8.2 Maintenance Schedule

To ensure safe and reliable operation, carry out the following checks and maintenance regularly, or have the checks carried out by another person.

	Weekly	Monthly	Annually
Visual Check	X		
Check Loopwheel Springs		X	
Check the push rims aren't working loose from the rim	X		
Have your wheelchair and wheels checked by a specialist dealer			X
Check the tyre pressure	X		
Check that Loopwheels™ are seated correctly and axles secure	X		
Check the parking brakes		X	

#### Visual Check

1. Examine your wheels for loose parts, cracks or other defects.
2. If you find anything, have your wheels checked immediately by your Loopwheels™ dealer or contact [info@loopwheels.com](mailto:info@loopwheels.com).

## **Check the springs of your Loopwheels™ - weekly**

1. Examine the springs for any signs of wear, cracks, looseness or other defects.
2. Listen for any clicking or creaking sound from the wheels as they turn.
3. If you find anything, have your wheelchair checked immediately by your loopwheels™ dealer or contact [info@loopwheels.com](mailto:info@loopwheels.com).

## **Check the push rims**

1. Examine the pushrims for any signs of wear, cracks, looseness or other defects.
2. Listen for any sound coming from between the push rim and the rim: a nut attaching the push rim to the wheel rim may have worked loose. Tighten all nuts so the push rim is fitted snugly to the wheel. But don't overtighten and break the nut!

## **Check the tyre pressure**

1. Check the tyre pressure – see 5.1.
2. Inflate the tyres to the required pressure.
3. Check the tyre tread at the same time.
4. If necessary, change the tyres.

## **Check that Loopwheels™ are seated correctly**

1. Pull on the Loopwheel™ to check that the removable axle is seated correctly. The wheel should not come off.
2. If the Loopwheels™ are not engaged properly, remove any dirt. If the problem persists, have the removable axles re-fitted by a specialist dealer.

## **Check the parking brakes**

### **IMPORTANT**

The parking brakes may need to be repositioned after replacing your rear wheels with loopwheels™



2. If you find that the setting is not correct, have the brakes correctly set by a specialist dealer.

### **⚠ CAUTION**

Loopwheels™ may sustain visibly undetectable damage as a result of a heavy collision or hard blow.

- It is essential to have your wheelchair and loopwheels™ checked by a specialist dealer after a heavy collision or hard blow.

## **8.3 Repairing or changing an inner tube**

1. Remove the Loopwheel™ and release any air from the inner tube.
2. Lift one tyre wall away from the rim using a bicycle tyre lever. Do not use sharp objects such as a screwdriver which could damage the inner tube.
3. Pull the inner tube out of the tyre.
4. Repair the inner tube using a bicycle repair kit or, if necessary, replace the tube.
5. Inflate the tube slightly until it becomes round.
6. Insert the valve into the valve hole on the rim and place the tube inside the tyre (the tube should lie right round the tyre with no creases).
7. Lift the tyre wall over the edge of the rim. Start close to the valve and use a bicycle tyre lever. When doing this, check all the way round to ensure that the inner tube is not trapped between the tyre and the rim.
8. Inflate the tyre to the maximum operating pressure. Check that no air is escaping from the tyre.

## **9.4 Cleaning**

Regular cleaning of your Loopwheels™ will help them last well. Regular cleaning will reveal loose or worn parts and enhance the smooth operation of your wheels. To operate properly and safely, your wheels must be cared for just like any other vehicle wheels.

### **⚠ IMPORTANT**

Sand and seawater can damage the bearings, and steel parts can rust if the surface is damaged.

- Only expose your loopwheels™ to sand and seawater for short periods, and clean the hub with fresh water after every trip to the beach.

### **⚠ IMPORTANT**

- Do not use coarse abrasives, aggressive cleaning products or high pressure cleaners.

Always use warm soapy water to clean

### **⚠ IMPORTANT**

- Do not use solvents or kitchen cleaners

1. Clean the metal parts with a soft, damp cloth.
2. Dry the hub carefully with a cloth after using it in the rain.
3. If the wheels are dirty, wipe off the dirt as soon as possible with a damp cloth and dry them carefully.

## **9. TROUBLESHOOTING**

### **9.1 Safety Information**

Faults may arise as a result of daily use, adjustments or changing demands on the wheels. The table below shows how to identify and repair faults.

### **⚠ WARNING**

- Contact your Loopwheels™ dealer immediately if you notice a fault with your wheels, e.g. a significant change in handling.

### **⚠ IMPORTANT**

- Some of the actions listed must be carried out by a specialist dealer or by the manufacturer. These are indicated.

## 9.2 Identifying and repairing faults

Fault	Possible cause	Action
The wheelchair does not travel in a straight line	Incorrect tyre pressure on one Loopwheel	Correct tyre pressure, see 5.1
	One or more spring is broken	Return wheel for repair or replacement via your specialist dealer
	Wheel bearings are dirty or damaged	Clean or replace the bearings via your specialist dealer
The brakes are gripping poorly or asymmetrically	Incorrect tyre pressure in one or both tyres	Correct tyre pressure, see 5.1
	Brake setting incorrect	Correct the brake setting, by seeking advice from your specialist dealer
Rolling resistance is very high	Tyre pressure is too low	Correct tyre pressure, see 5.1
The wheel makes a clicking noise	One or more spring is loose or broken	Return wheel for repair or replacement, via your specialist dealer
The wheel makes a shushing noise	One or more nuts fixing the push rim to the rim is loose.	Tighten any loose nuts. Recommended torque is 2.5Nm
The wheel makes a shushing noise	One or more rivnuts fixing the push rim to the rim has broken.	Contact your specialist dealer.
There is sideways movement when the wheel spins; the wheel doesn't run "true".	This is a natural characteristic of Loopwheels™ and is not a fault. Loopwheels™ have more lateral movement than spoked wheels. If you feel this is excessive, contact your Loopwheels™ dealer or send a video to <a href="mailto:info@loopwheels.com">info@loopwheels.com</a> for advice.	

# 10. AFTER USE

## 10.1 Storage

### **▲ IMPORTANT**

Risk of damage to the product

- Do not store the wheels near heat sources.
- Never store other items on top of the wheels.
- Store the wheels indoors in a dry environment.

After long-term storage (more than three months) we recommend the wheels be inspected in accordance to chapter 9 Maintenance.

## 10.2 Disposal

For correct disposal, contact your specialist dealer or ask your town or district council about local waste management companies. Be environmentally aware and dispose of your loopwheels™ properly. Disposal is subject to national and local regulations. Safely, your wheels must be cared for just like any other vehicle wheels.

# 11. TECHNICAL DATA

## 11.1 Dimensions and weight

Dimension and weight may alter according to different configurations of push rims and tyres.

A	Wheel diameter	Extreme: 507mm (ETRTO 47-507mm) Urban: 540mm (ETRTO 25-540mm) Or 559mm (ETRTO 25 – 559mm)
B	Wheel width at widest point (without push rim)	74mm
C	Wheel width at hub	74mm
D	Bearing width at faces	1.8 inches 45.8mm
E	Weight (without push rim or tyres)	Urban - 1.36kg Extreme - 1.33kg
F	Push rim offset (distance between rim and push rim)	Loopwheels Urban has two options: Narrow - 11mm Wide - 19mm Loopwheels Extreme: 15mm
G	Maximum load	120kg

## 11.2 Environmental conditions

Do not expose the wheels to temperatures below -40 °C or above 40 °C.

## 11.3 Materials

The components in Loopwheels™ Urban and Extreme are made of the following materials:

Springs («loops»)	Composite of Glass Fibre, Carbon Fibre and cured Epoxy resins
Rim, hub and rim connectors	Aluminium
Bearings	Steel / Aluminium
Screws and bolts	Steel / Titanium
Push rim	Aluminium
Push rim spacer	Polyamide (nylon)







© 2023 Jelly Products Ltd All rights reserved. Republication, duplication or modification in whole or in part is prohibited without prior written permission from Jelly Products Ltd. The name Loopwheels™ and the Loopwheels™ logo are registered Trade Marks owned by Jelly Products Ltd.

The information in this manual may be subject to change without notice. Latest updates are at <https://loopwheels.com/technical/user-manual/>

	
 <b>Jelly Products Limited</b> Unit 202 Boughton Industrial Estate, Newark Nottinghamshire, NG22 9LD, UK	
 <b>Advena Limited</b> Tower Business Centre, 2 <sup>nd</sup> Floor, Tower Street Swatar, BKR 4013, Malta	
 <b>506093580LW2H7</b>	
<a href="https://loopwheels.com/technical/user-manual/">https://loopwheels.com/technical/user-manual/</a>	